

Technical Datasheet

EasyLan® 30° Keystone Panel 19" 1U

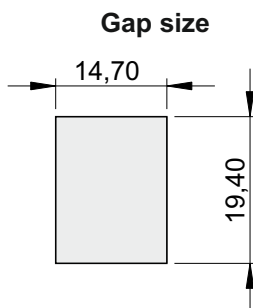
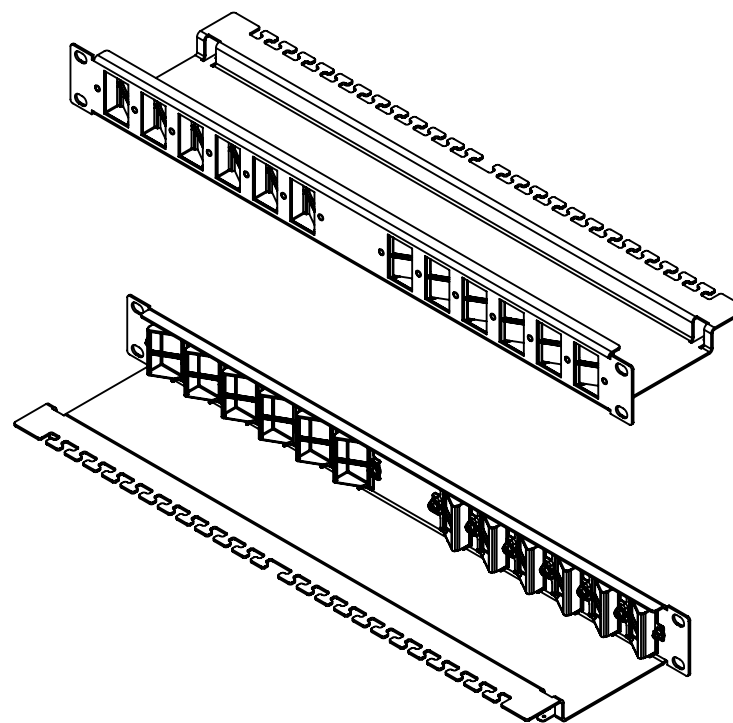
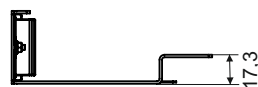
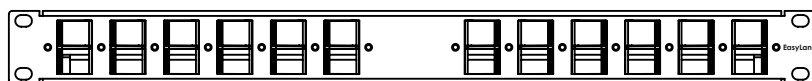
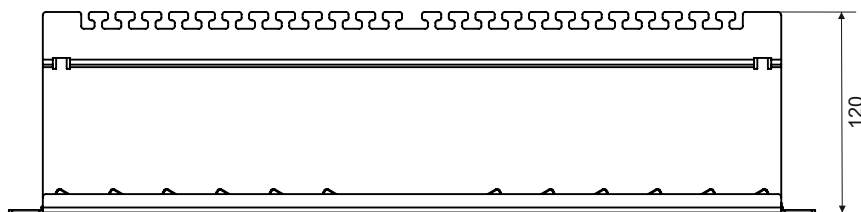

Material	stainless steel
Surface	powder-coated
Adapter Material	zinc diecast

	drawn	13.01.2016	MJ
	appr.	14.01.2016	GF
Titel:			
EasyLan® 30° Keystone Panel 19" 1U for 24 Keystones			
Drawing Number:			
ZN-BL151068			
d	Aenderung Spr.	08.12.2023	TG
c	Aenderung Bezeich.	02.03.2017	GF
b	Aenderung Itr	13.01.2016	MJ
a	Neuerstellung	09.09.2015	MJ
Rev. Index	Revision code	Date	Name



Dimensions: mm

Original: DIN A4

Sheet 1 of 2

Technical Datasheet

Variante 2 (left):

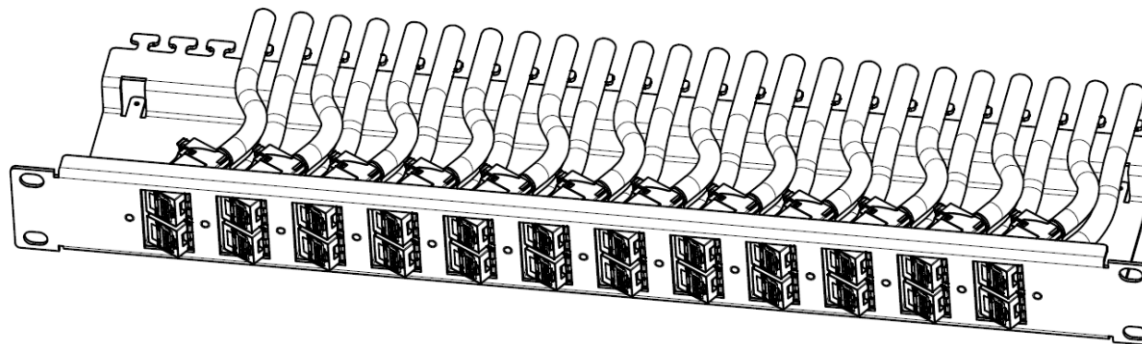

Variante 3 (right):

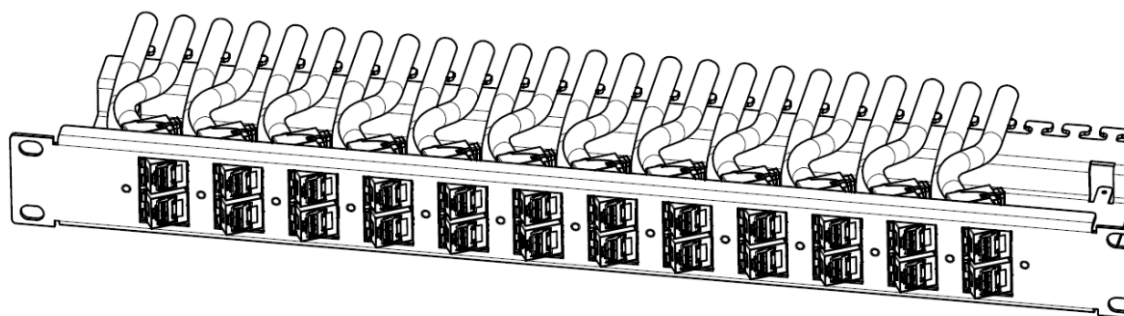

Material	stainless steel
Surface	powder-coated
Adapter Material	zinc diecast

d c b a	Änderung Spr. Änderung Bestelz. Änderung lfr. Neuerstellung	08.12.2023 02.03.2017 13.01.2016 09.09.2015	TG GF MJ MJ	drawn	13.01.2016	MJ
				appr.	14.01.2016	GF
Rev. Index	Revision code	Date	Name	Titel: EasyLan® 30° Keystone Panel 19" 1U for 24 Keystones Drawing Number: ZN-BL151068		
				 EasyLan® ...for a better connectivity		Dimensions: mm Original: DIN A4 Sheet 2 of 2